



**C 150**

# LIST OF THE EXPLODED VIEWS



*SHELL ASSY*

*COOLING SYSTEM*

*HYDRAULIC CIRCUIT*

*ELECTRIC PARTS*



# C 150

## SHELL ASSY

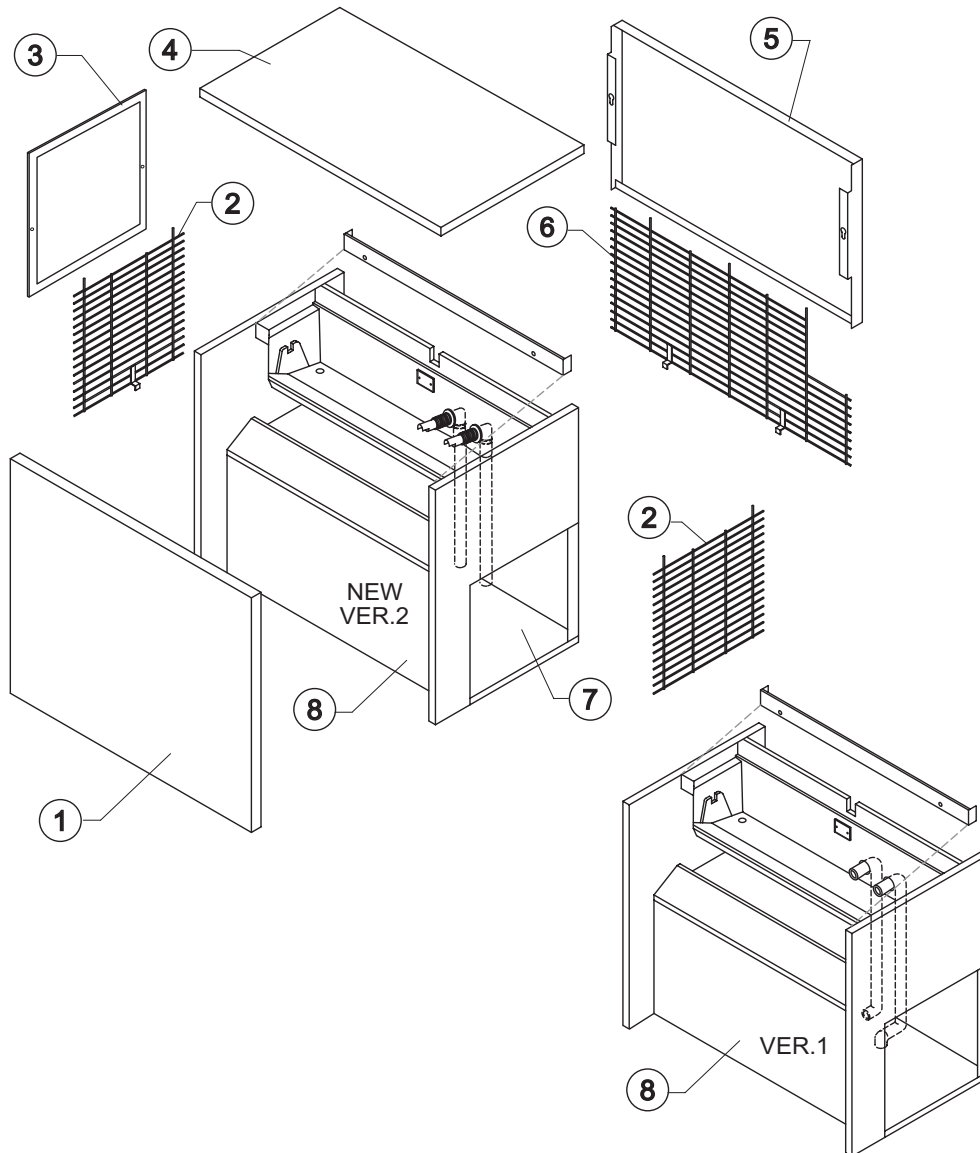

Rev. 5 - 21/07/2005

Ref.	Spare Description	Code
1	Front Panel Assembly	C22125B
2	Side Grid	D12036
3	Filter	Air Cooled Version 18163
4	Top Assembly	C22124
5	Rear Panel	22127
6	Rear Grid	Current Version D12068
6	Rear Grid	Till s/n. 123682 D12035
7	Base Plate	21078
8	Foamed Cabinet Assy	See Table -

### Ref. 8 - Foamed Cabinet Assy

Code	Condensation	Note
C11020A	Air	Version 2
C11020W	Water	Version 2
C11020		Version 1



# C 150

# COOLING SYSTEM

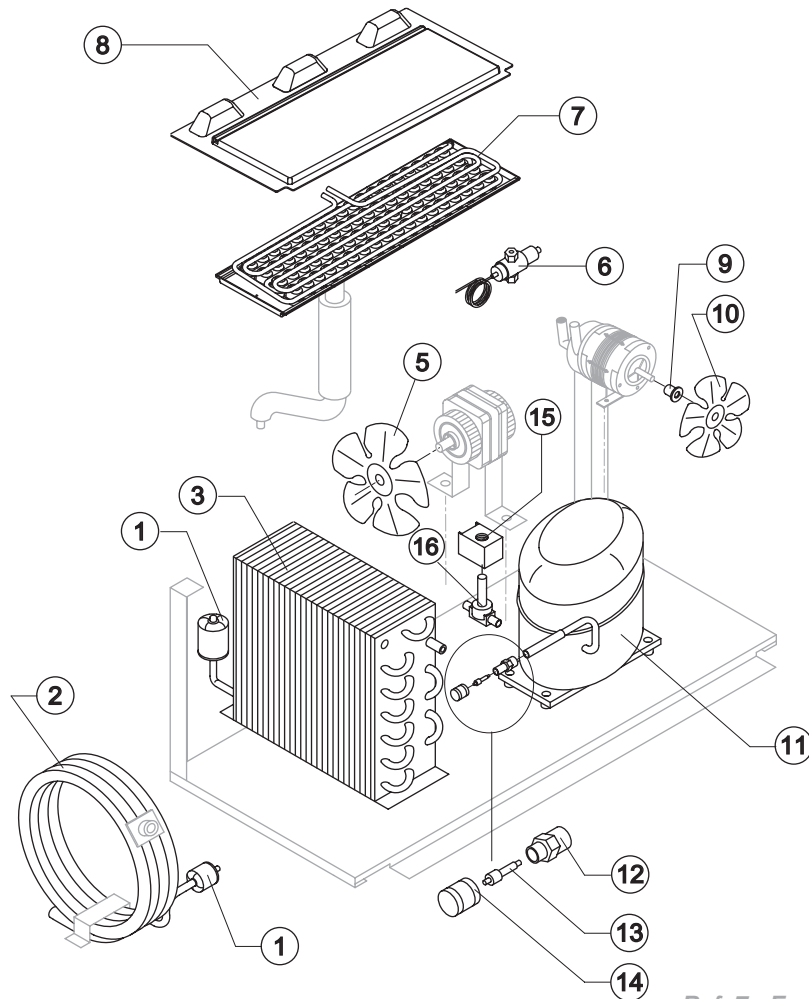

### Common Parts

Ref.	Spare Description	Code
1	Solid Core Drier	14084
7	Evaporator	See Table
8	Evaporator Cover Panel	Current Version 10454
8	Evaporator Cover Panel	Till s/n. 226491 10058
9	Fan Fixing Hub	10014
10	Sucking Fan	10213
11	Compressor	See Table
12	Vacuum-Charge Valve Body	14007
13	Vacuum-Charge Valve Device	14005
14	Vacuum-Charge Valve Plug	14006
15	Hot Gas Valve Coil	See Table
16	Hot Gas Valve Body	20409

### Parts for Air-Cooled Version Only

Ref.	Spare Description	Code
3	Air Condenser	Current Version 20426
3	Air Condenser	Till s/n. 43017 20148
4	Conveyor	Only 110V 60 Hz 10238
5	Sucking Fan (Current Version)	220V 50 Hz, 230V 60 Hz 20407
5	Sucking Fan (Till s/n. 43017)	220V 50 Hz, 230V 60 Hz 20153
5	Sucking Fan	110V 60 Hz 20031

### Parts for Water-Cooled Version Only

Ref.	Spare Description	Code
2	Water Condenser	14081
5	Sucking Fan	Till s/n. 219565 10213
6	Pressostatic Valve	20210

### Ref. 7 - Evaporator

Kind of Cube	Code
18 g. (Standard)	D10214
33 g.	D10092
13 g.	D10126
42 g.	D10477

### Ref. 11 - Compressor

Tension	Code
220/240V 50 Hz	23438
220/230V 60 Hz	23593
110/115V 60 Hz	23586

### Ref. 15 - Hot Gas Valve Coil

Tension	Code
220/240V 50 Hz	23091
220/230V 60 Hz	23091
110/115V 60 Hz	23256

Rev. 5 - 21/07/2005



# C150

# HYDRAULIC CIRCUIT

### Common Parts

Ref.	Spare Description	Code
1	Ice Cubes Slide	See Table
3	Flags Support Assy	C22134
4	Inner Basin	10055
5	Sprayers Bar Plug	10012
6	Sprayers Bar Assembly	See Table
7	Sprayer	D20002
8	Overflow Cap	Till s/n. 243901
9	Overflow Pipe	10133
10	OR Gasket for Overflow Pipe	20233
11	Water Outlet Nipple	10472
12	Silicone Gasket	13006
13	Slide Keep Plate	Till s/n. 234237
14	Pump Suction Filter	20005
15	Sprayers Feeding Pipe Connection	C13037
16	Semirigid Polyethylene Gasket	13007
17	Bin Discharge Nut	10096
19	Fitting Locking Ring	Version 2
20	Pump Suction/Delivery Pipe	Version 2
21	Fitting of the Pump Suction/Delivery Pipes	Version 2
22	Gasket for Pump Suction/Delivery Pipes	Version 2
23	Pump Suction Pipe	Version 1
24	Pump Delivery Pipe	Version 1
25	Fixing Screw	20009

### Parts for Air Cooled Version Only

Ref.	Spare Description	Code
18	Discharges Manifold	C10006

### Parts for Water Cooled Version Only

Ref.	Spare Description	Code
18	Discharges Manifold	C26452

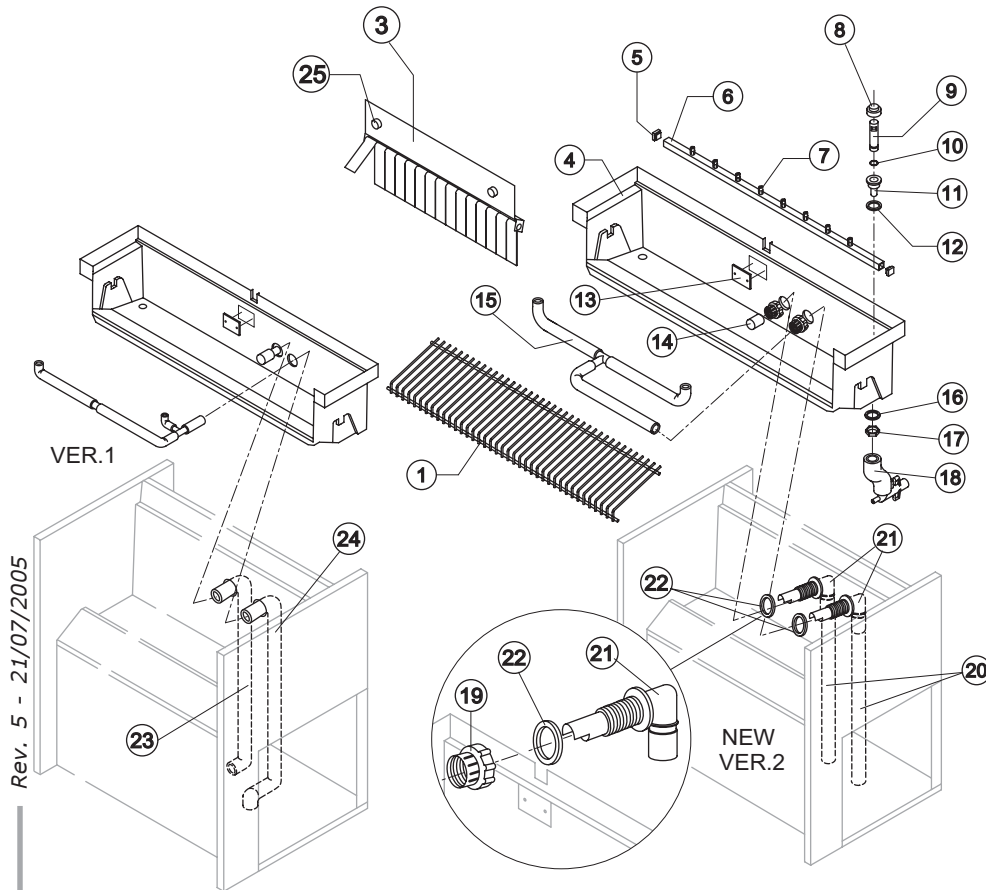

Rev. 5 - 21/07/2005

### Ref. 1 - Ice Cube Slide

Kind of Cube	Code
18 g. (Standard)	D12022
33 g.	D12033
13 g.	D12040
42 g.	D12033

### Ref. 4 - Sprayers Bar Ass.

Kind of Cube	Code
18 g. (Standard)	C20144
33 g.	C20157
13 g.	C20200
42 g.	C20157



# C 150

# ELECTRIC PARTS

## Common Parts

Ref.	Spare Description	Code
2	Fan Motor	See Table
3	1 Way- Water Inlet Valve	See Table
8	Pump	See Table
10	Contactator	See Table
13	Bin Thermostat	R23421
14	Evaporator Thermostat	R23591
15	Timer	See Table

## Parts for Air-Cooled Version Only

Ref.	Spare Description	Code
9	Anti Radio Interference Filter	Only 220V 50 Hz C23459
12	Condenser Pressure Switch	23175

## Parts for Water-Cooled Version Only

Ref.	Spare Description	Code
1	Safety Thermostat	Till s/n. 105976 C23114
4	2 Ways- Water Inlet Valve (Till s/n. 123682)	See Table
5	1 Way- Water Inlet Valve	10368
11	Safety Pressure Switch	23342

## Ref. 8 - Pump

Tension	Version 1	Version 2
220/240V 50 Hz	23068	23462
220/230V 60 Hz	23068	23462
110/115V 60 Hz	23264	23663

## Ref. 2 - Fan Motor

Tension	Air	Water Till s/n. 219565
220/240V 50 Hz	23121	23029
220/230V 60 Hz	23121	23029
110/115V 60 Hz	23621	23683

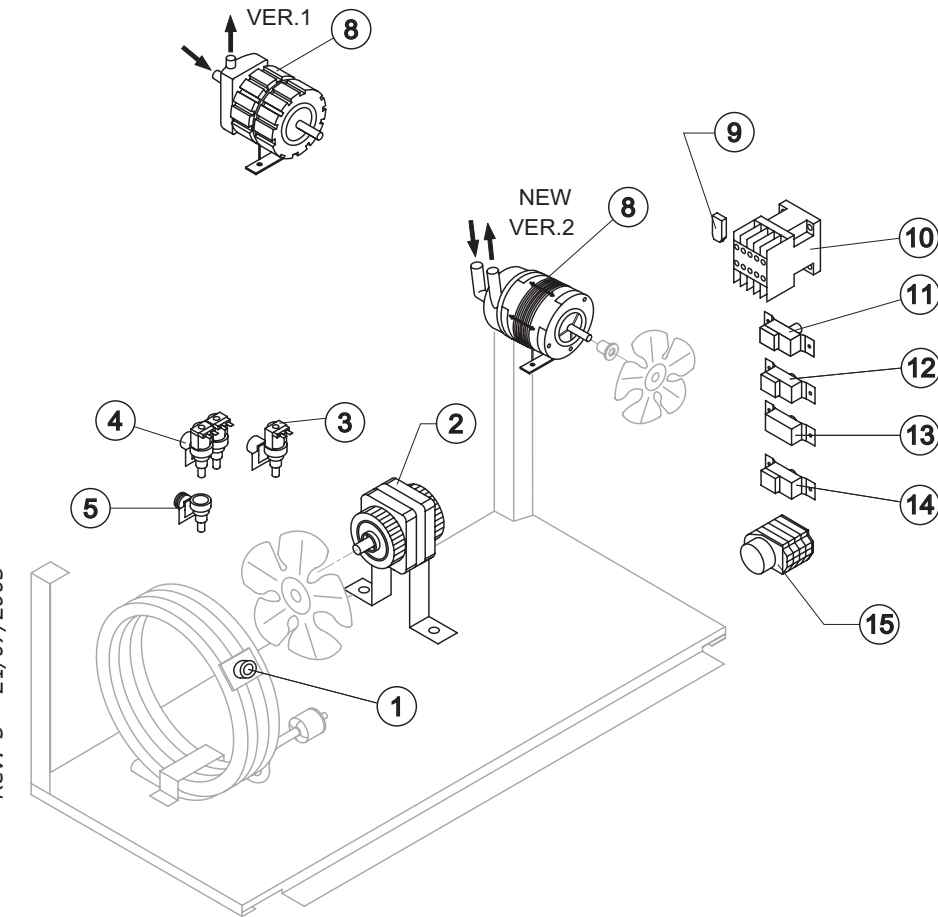

### Ref. 3 - 1 Way- Water Inlet Valve

Tension	18g/13g Cube	33g Cube	42g Cube
220/240V 50 Hz	23220	23220	23787
220/230V 60 Hz	23220	23787	23787
110/115V 60 Hz	23281	23789	23789

### Ref. 4 - 2 Ways- Water Inlet Valve

Tension	Code
220/240V 50 Hz	23138
220/230V 60 Hz	23138
110/115V 60 Hz	23282

### Ref. 10 - Contactator

Tension	Code
220/240V 50 Hz	23594
220/230V 60 Hz	23594
110/115V 60 Hz	23625

### Ref. 15 - Timer

Tension	18 g Cube	33 g Cube	13 g Cube	42 g Cube
220/240V 50 Hz	23247	23248	23472	23780
220/230V 60 Hz	23222	23780	23247	23780
110/115V 60 Hz	23258	23786	23258	23786

Rev. 5 - 21/07/2005